

FALLBROOK XL



A CRH COMPANY

crlaurence.com • usalum.com

Quote

Order

partitions@crlaurence.com

Company, customer no:

Project:

Choose system type (A1 - D):

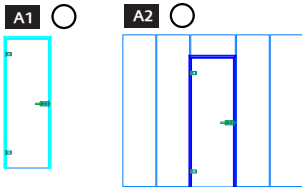

Additional Info:

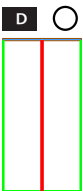
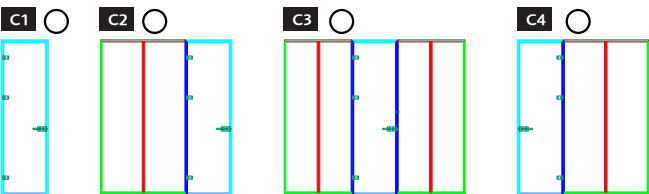
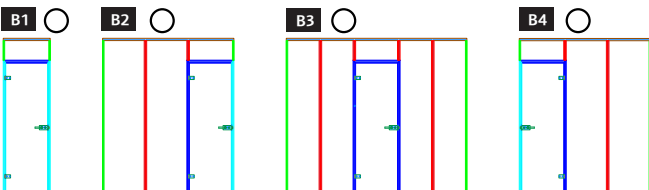

Note: Fallbrook XL system with sidelites requires a minimum of two panels to either side of door opening for glazing purposes.

SYSTEM VIEW = REBATE SIDE = CLIP PROFILE SIDE (FRAME PROFILES)

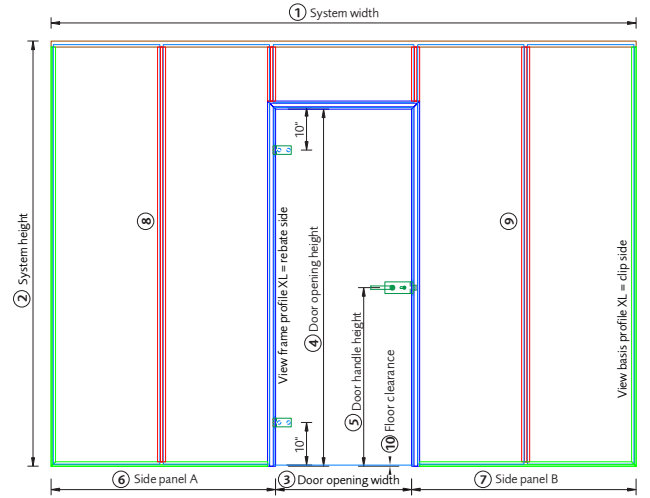

HORIZONTAL SECTION

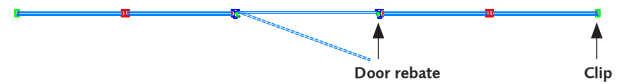

Opening direction door:

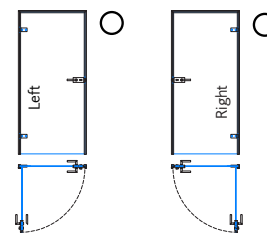

1. System width*:	<input type="text"/>	6. Side panel A*:	<input type="text"/>
2. System height*:	<input type="text"/>	7. Side panel B*:	<input type="text"/>
3. Door opening width*:	<input type="text"/>	8. Quantity intermediate vertical profile side panel A*:	<input type="text"/>
4. Door opening height*:	<input type="text"/>	9. Quantity intermediate vertical profile side panel B*:	<input type="text"/>
5. Door handle height:	<input type="text"/>	10. Floor clearance:	<input type="text"/>

*Required for quoting

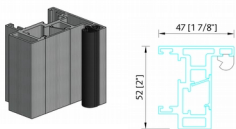

DOOR FRAME PROFILES

Door frame profile XL for wall connection

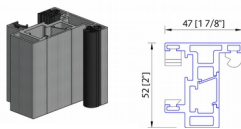

Door frame profile XL for glass connection

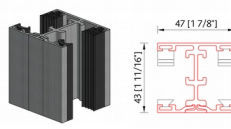

FIXED FRAME PROFILES

Fixed frame glazing profile XL for intermediate vertical

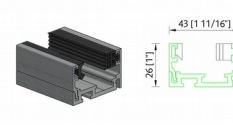

Fixed frame glazing profile XL for floor and wall (optional at ceiling)

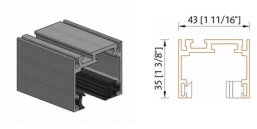

Fixed frame glazing profile XL for ceiling

DOOR SIZE LIMITATIONS
 Maximum door width: 35-7/16" (900 mm)
 Maximum door weight: 165 lbs (75 kg)

HINGE REQUIREMENTS – Number of hinges required:
 2 hinge: door weight up to 110 lbs (50 kg) OR door height up to 78-3/4" (2000 mm)
 3 hinges: door weight over 110 lbs (50 kg) up to 165 lbs (75 kg) OR door height over 78-3/4" (2000 mm) up to 98-7/16" (2500 mm)
 4 hinges: door height over 98-7/16" (2500 mm) to maximum height 118" (3000 mm) regardless of weight

ELEMENT FINISHINGS:

- | | | | | | |
|--------------------|------------------------|----------------------------|------------------------------|-----------------------------------|---|
| Door: | Glass type | <input type="radio"/> FTG | <input type="radio"/> LSG | Profile finishes: | <input type="radio"/> Satin anodized |
| | Glass thickness | <input type="radio"/> 3/8" | <input type="radio"/> 1/2" | | <input type="radio"/> Black satin anodized |
| Fixed part: | Glass type | <input type="radio"/> FTG | <input type="radio"/> LSG | | <input type="radio"/> Brushed nickle anodized |
| | Glass thickness | <input type="radio"/> 1" | <input type="radio"/> 1 1/8" | Gasket color side panels*: | <input type="radio"/> Black |
| | | | | | <input type="radio"/> Grey |
- (glass thicknesses from 20 – 24 mm are also available)

FTG = Fully tempered glass LSG = Laminated safety glass

*Black gasket is default color for Black satin anodized profiles and Brushed nickle anodized profiles.
Grey gasket is default for Satin anodized profiles.

PLEASE SELECT SINGLE FITTINGS AND SETS:

CRL Fallbrook Square Hinge



- FHSBN Brushed nickel
- FHSMBL Matte black
- FHSSA Satin anodized

CRL Fallbrook D-Shape Hinge

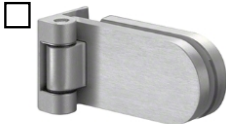

- FHDBN Brushed nickel
- FHDMBL Matte black
- FHDSA Satin anodized

CRL Fallbrook Square Latch



- FLSBN Brushed nickel
- FLSMBL Matte black
- FLSSA Satin anodized

CRL Fallbrook D-Shape Latch



- FLDBN Brushed nickel
- FLDSA Satin anodized

**** Not available in MBL**

CRL Fallbrook Handle Set Rounded



- FLHBN Brushed nickel
- FLHMBL Matte black
- FLHSA Satin anodized

CRL Fallbrook Handle Set Square Mitered



- FLHMTBN Brushed nickel
- FLHMTMBL Matte black
- FLHMTSA Satin anodized

CRL Fallbrook Square Latch with cylinder



- FLKSBN Brushed nickel
- FLKSMBL Matte black
- FLKSSA Satin anodized

CRL Fallbrook D-Shape Latch with cylinder



- FLKDBN Brushed nickel
- FLKDZA Satin anodized

**** Not available in MBL**