

NEW! SERENITY SERIES SLIDING DOOR SYSTEM

- Unique System With Rollers Above the Header Support Bar
- System Features One Sliding Door and One Fixed Panel
- Use of Minimal Hardware Gives Door an Almost Floating Appearance
- Specially Designed Roller Bearings Allow Easy Opening and Closing of Door
- Accessory Kit Available for 90 Degree Return Panels
- For 5/16" or 3/8" (8 or 10 mm) Thick Tempered Glass
- Choice of Durable Polished or Brushed Stainless Steel Finishes



Our New Serenity Series Sliding Door System has an entirely different look from traditional sliding shower door systems. The use of minimal hardware provides a frameless look that gives the enclosure an almost floating appearance. Specially designed roller bearings allow for quiet, easy opening and closing of the door. This unique roller system operates above the header support bar that spans the top of the enclosure.

One sliding and one fixed panel make the 180 Degree Standard Kit beautiful and practical. The Kit includes all items pictured to the right, with the exception of the 90 Degree Accessory Kit. The durable polished or brushed stainless steel units will work with 5/16" or 3/8" (8 or 10 mm) thick tempered glass (not included).

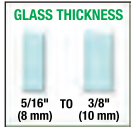

SPECIFICATIONS:

Glass Thickness Range: 5/16" or 3/8" (8 or 10 mm)
Tempered Safety Glass (Not Included)

Material: Stainless Steel

Maximum Door Size: Do Not Exceed Either 30" (762 mm) Wide or 88 Pounds (40 kg)

Fabrication: Holes Required in Both Door and Fixed Panel (see crlaurence.com)

STANDARD 180 DEGREE KIT INCLUDES:

- One 78-3/4" (2 m) Length Header Support Bar
- Two Rollers
- Two Stoppers
- Two Anti-Lift Fittings
- Two Track Holder Fittings for Wall
- Two Track Holder Fittings for Fixed Panel
- One Thru-Glass Pull
- One Door Guide



78-3/4" (2 m) Header Support Bar. Low Profile 1-1/8" (28.6 mm) Height

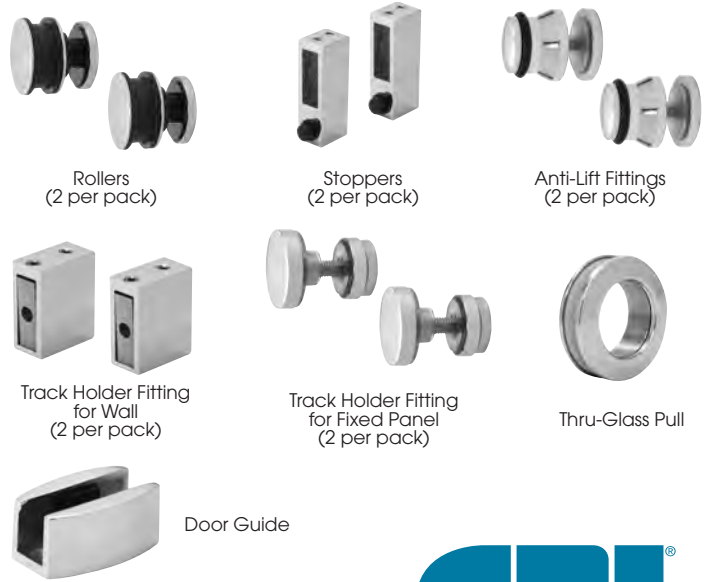

Rollers (2 per pack)

Stoppers (2 per pack)

Anti-Lift Fittings (2 per pack)

Track Holder Fitting for Wall (2 per pack)

Track Holder Fitting for Fixed Panel (2 per pack)

Thru-Glass Pull

Door Guide

BRUSHED STAINLESS CAT. NO.	POLISHED STAINLESS CAT. NO.	DESCRIPTION
SERF2BS	SERF2PS	Standard 180° Kit
SER90BS	SER90PS	90° Accessory Kit
SERH2BS	SERH2PS	78-3/4" (2 m) Header Support Bar Only
SERR2BS	SERR2PS	Rollers (2 / Pack)
SERS2BS	SERS2PS	Stoppers (2 / Pack)
SERAL2BS	SERAL2PS	Anti-Lift Fittings (2 / Pack)
SERW2BS	SERW2PS	Track Holder Fittings For Wall (2 / Pack)
SERFP2BS	SERFP2PS	Track Holder Fittings For Fixed Panel (2 / Pack)
SERDG2BS	SERDG2PS	Door Guide
SERP2BS	SERP2PS	Thru-Glass Pull

ACCESSORY KIT FOR 90 DEGREE RETURN

Sold Separately



Track Holder Fitting for Wall (2 per pack) Already Included in Standard 180° Kit

C.R. LAURENCE CO. | crlaurence.com | usalum.com

PHONE: (800) 421-6144 Ext. 7740 | FAX: (800) 458-7496 | EMAIL: showers@crlaurence.com



AVDB4071-8/11

COTTAGE SERIES SLIDING DOOR SYSTEM

Frameless Sliding Bypass Shower Door Kits

- Stock Kits in Four Finishes, with a Choice of Metal or Clear Jamb
- Custom Inline and Angled Kits Made to Your Specifications
- Extrusions and Hardware Also Available as Separate Components

Cottage Series Frameless Sliding Shower Door Kits are easy to install with smooth gliding bolt-through top hangers, no waiting for messy adhesives to dry. Individual supplemental extrusions and hardware components are available to convert a standard kit into an angled enclosure or wider inline unit for a customized look.

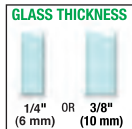

CK Series with Clear Side Jamb

No vertical metal for the popular "all-glass look". Smooth gliding top hung hidden rollers makes for easy cleaning.



DK Series with Metal Side Jamba

Utilizes metal side jamba for a more traditional appearance. Bolt-through top hangers allow for immediate installation.



HEADER

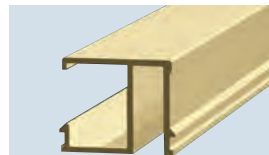

HEADER FILLER



TOP HANGER (1/4" GLASS)

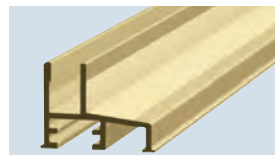

SIDELITE SILL

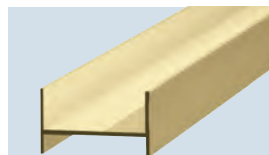

SIDE JAMB



TOP HANGER (3/8" GLASS)

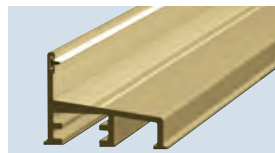

BOTTOM SILL

AVAILABLE IN FOUR STANDARD FINISHES



Brite Anodized

Brite Gold Anodized

Brushed Nickel

Oil Rubbed Bronze

C.R. LAURENCE CO. | crlaurence.com | usalum.com

PHONE: (800) 421-6144 Ext. 7740 | FAX: (800) 458-7496 | EMAIL: showers@crlaurence.com

